

LAMM



C100

Baldanzi & Novelli



### Fiancate

Fiancata a terra disponibile con profondità standard (34 cm) o maggiorata (44 cm). Pannelli laterali in due altezze con rivestimento in tessuto, in pelle o in essenze naturali e con telaio strutturale in acciaio a vista. Nella versione su barra le fiancate intermedie sono tamponate con pannelli laterali che si appoggiano sulla trave, mentre quelle iniziali possono anche arrivare fino a terra. L'installazione può avvenire su piano orizzontale, inclinato o su gradoni, in file diritte o in curva.

### Poggia-braccio

Poggia-braccio riportato in massello di legno verniciato, coordinato alle fiancate, oppure interamente imbottito e rivestito in tessuto o pelle.

### Sides

Floor-level side available in standard depth (34 cm) or increased depth (44 cm). Two-height side panels with fabric, leather or natural wood covering, with visible structural steel frame. In the beam-mounted version the intermediate sides are filled using side panels that rest on the beam, whereas the starting sides can reach the ground. Installation on horizontal and inclined floors or on steps, in straight or curved rows.

### Armrest

Painted solid wood added armrest, coordinated with the sides, or fully padded and covered with fabric or leather.



### Sedile e schienale

Sedile con dispositivo a gravità che ne consente il ribaltamento con movimento auto-frenante. Schienale, alto o basso, posizionabile con due diverse angolazioni per favorire sempre una perfetta visuale, sia in platea che in galleria.

### Seat and backrest

A gravity device allows the seat to tip up with a cushioned movement. High or low backrest available with inclination at two different angles to enable a perfect view at all times, both in stalls or in galleries.

### Personalizzazione

Poltrona qualificata da una serie di accessori funzionali, che consentono di personalizzare ogni intervento con soluzioni specifiche. Caratterizzata da un design nitido e lineare, esprime forti requisiti ergonomici di comfort.

### Customisation

Armchair qualified by a series of functional accessories that enable each installation to be customised with specific solutions. Characterised by a straightforward design, this armchair provides high levels of ergonomic comfort and safety.







## Tipologie

Prodotta sia con fiancata a terra che su barra, la poltrona si adatta a qualsiasi progetto (è disponibile anche un sistema accessorio per l'amovibilità delle poltrone). La versione su barra è disponibile anche con piedi anti-ribaltamento senza fissaggio a pavimento. La fiancata può essere completamente imbottita o in legno verniciato.

## Versions

Produced both with floor-length side and on beam, the armchair is suitable for any project (an accessory system to move the armchairs is also available). The beam-mounted version is also available with anti-tilt feet that do not require floor fixing. The side can be fully padded or in painted wood.



## Finiture - Finishes

\*Textures p. 260

	Sedile, Schienale Seat, Backrest	Fiancate Sides	Poggia-braccio riportato Added armrest	Struttura: Struttura portante a vista, Barra Structure: Visible bearing structure, Beam
Tessuti Fabrics	Inca King Trevi Revive 1 Extrema Au Dualcycle Net Luna CS Remix 2 Steelcut Trio 2 Pelle - Leather	Inca King Trevi Revive 1 Extrema Au Dualcycle Net Luna CS Remix 2 Steelcut Trio 2 Pelle - Leather	Inca King Trevi Revive 1 Extrema Au Dualcycle Net Luna CS Remix 2 Steelcut Trio 2 Pelle - Leather	
Laminati HPL HPL Laminates				
Legno verniciato Painted wood		Rovere - Oak Rovere grigio - Grey oak Eucalipto - Eucalyptus		
Vernici Paints				Nero - Black Argento - Silver Bronzo - Bronze Grafite - Graphite
Poliuretano rigido Rigid polyurethane				
Legno massello verniciato Painted solid wood			Rovere - Oak Rovere grigio - Grey oak Eucalipto - Eucalyptus	

	Accessori: Tavoletta di scrittura Accessories: Writing tablet	Accessori: Tavolino retro-schienale Accessories: Backrest table	Accessori: Pannello sotto-sedile, Pannello retro-schienale, Carter basso retro-schienale Accessories: Under seat panel, Backrest panel, Low guard for backrest
Tessuti Fabrics			
Laminati HPL HPL Laminates		Rovere - Oak Rovere grigio - Grey oak Eucalipto - Eucalyptus	
Legno verniciato Painted wood			Rovere - Oak Rovere grigio - Grey oak Eucalipto - Eucalyptus
Vernici Paints			
Poliuretano rigido Rigid polyurethane	Nero - Black		
Legno massello verniciato Painted solid wood			

## Dimensioni - Dimensions

C100 schienale basso - C100 with low backrest

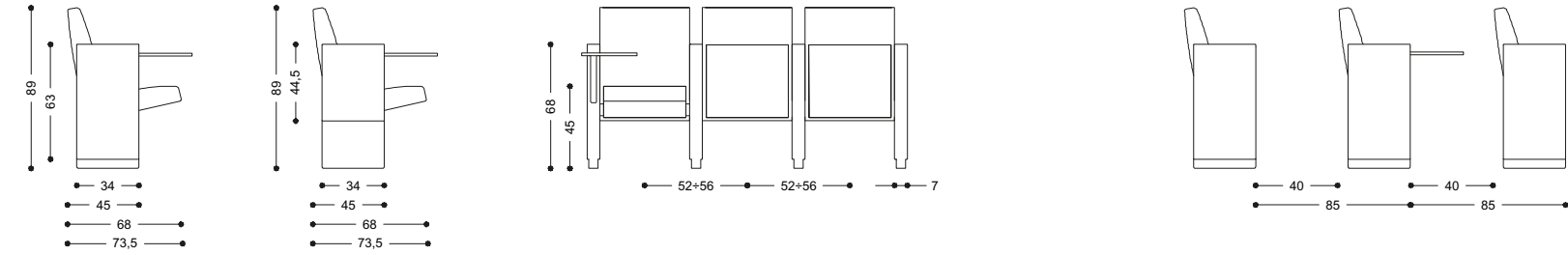

C100 schienale basso - C100 with low backrest

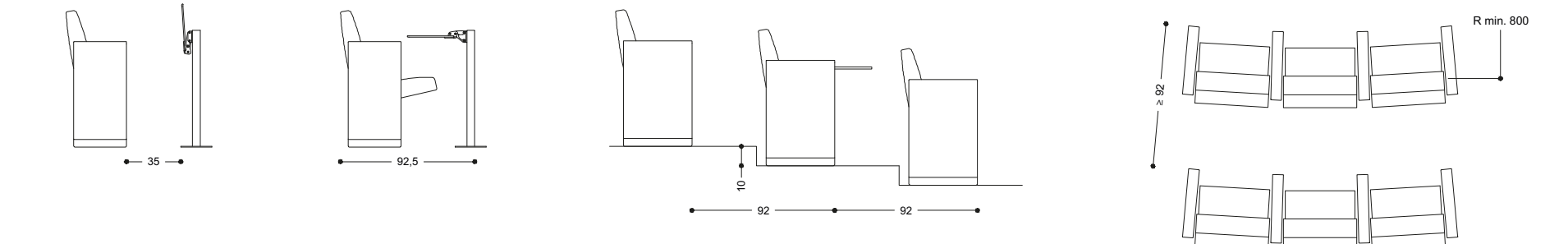
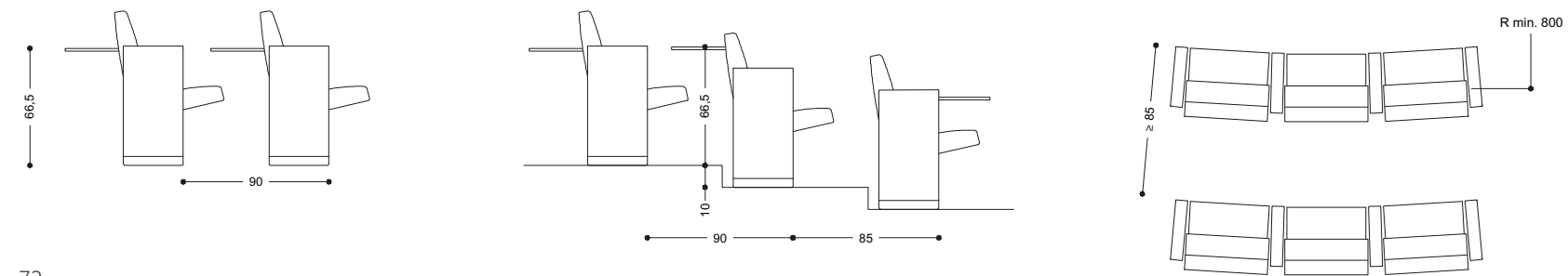
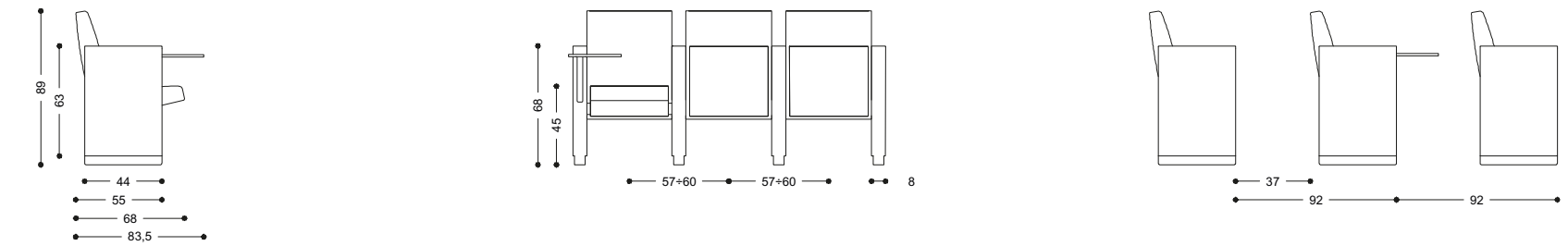
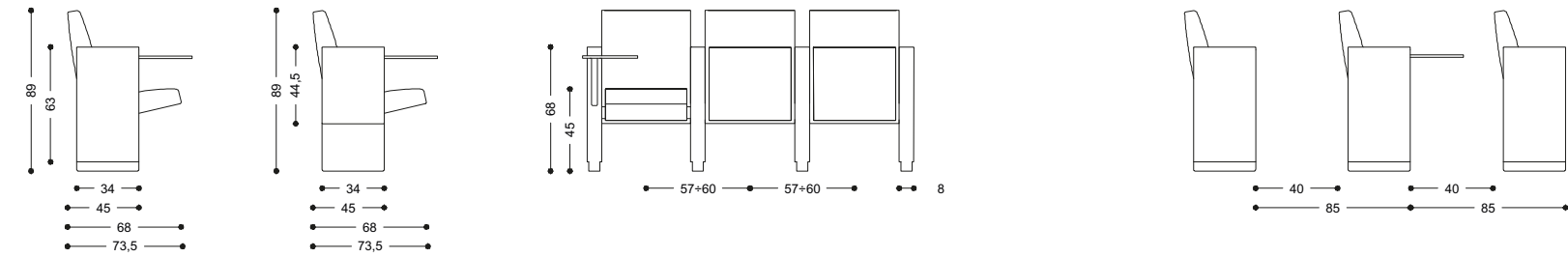
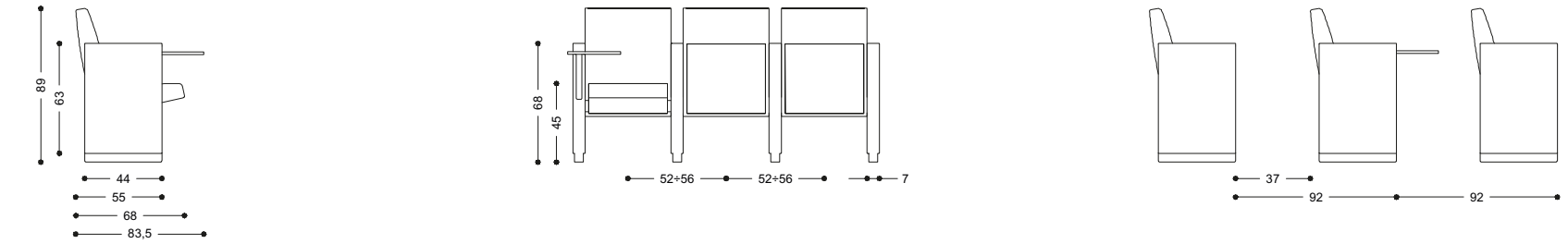

## Dimensioni - Dimensions

C100 schienale alto - C100 with high backrest

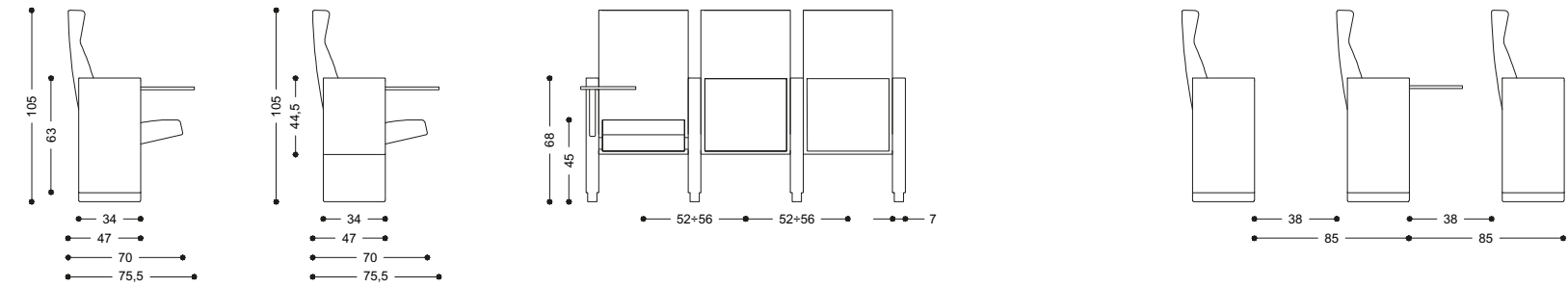

C100 schienale alto - C100 with high backrest

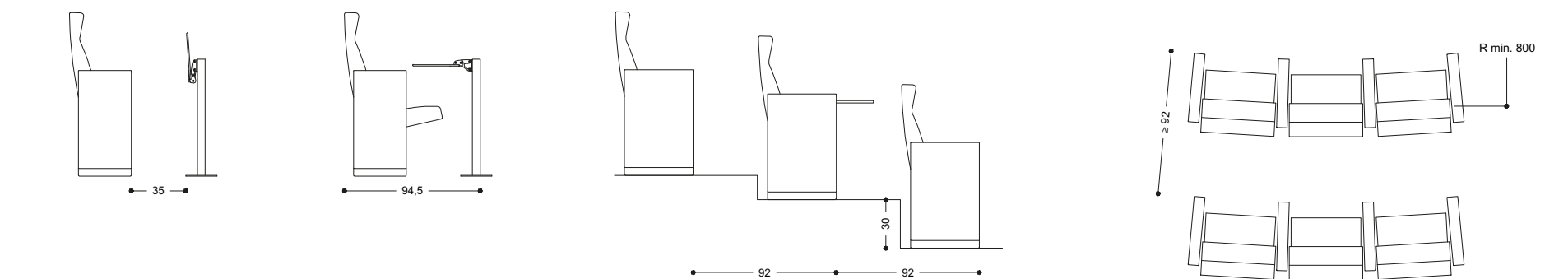
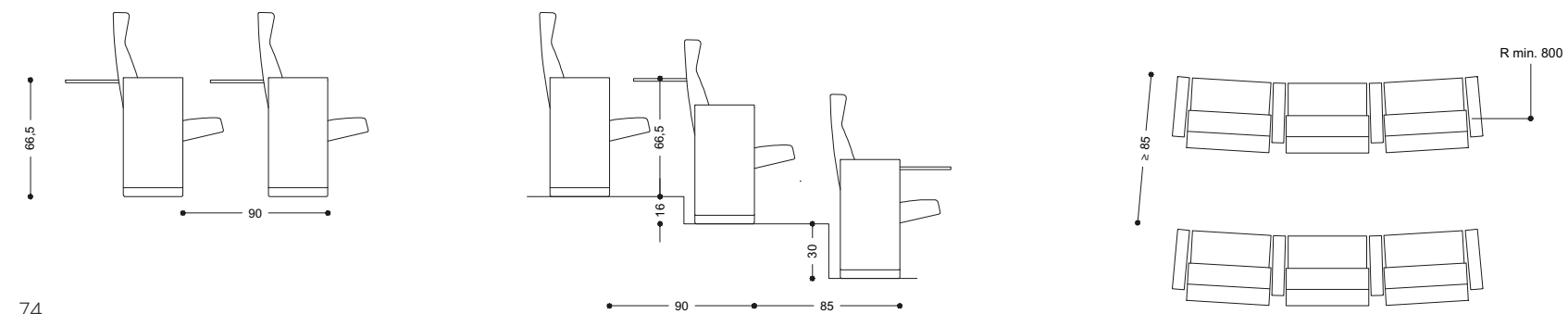
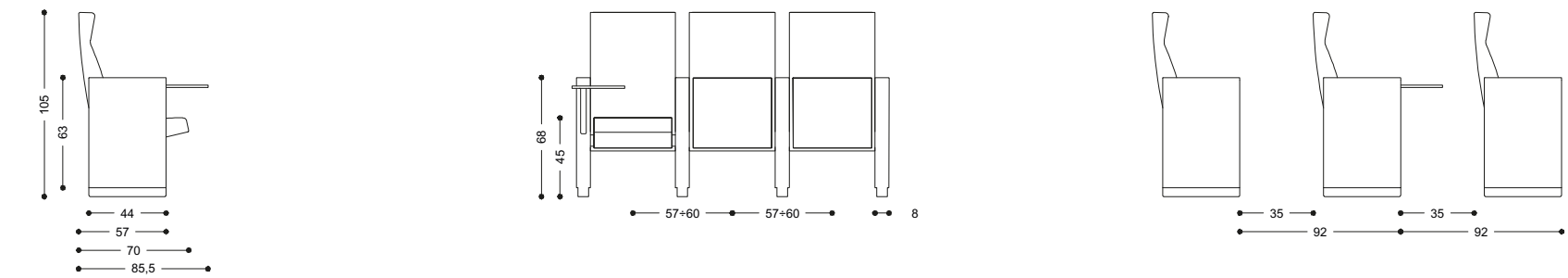
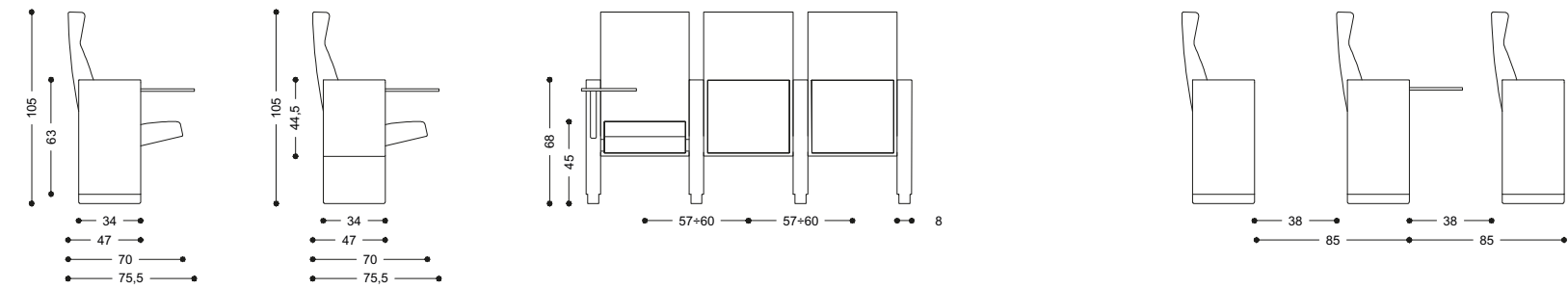
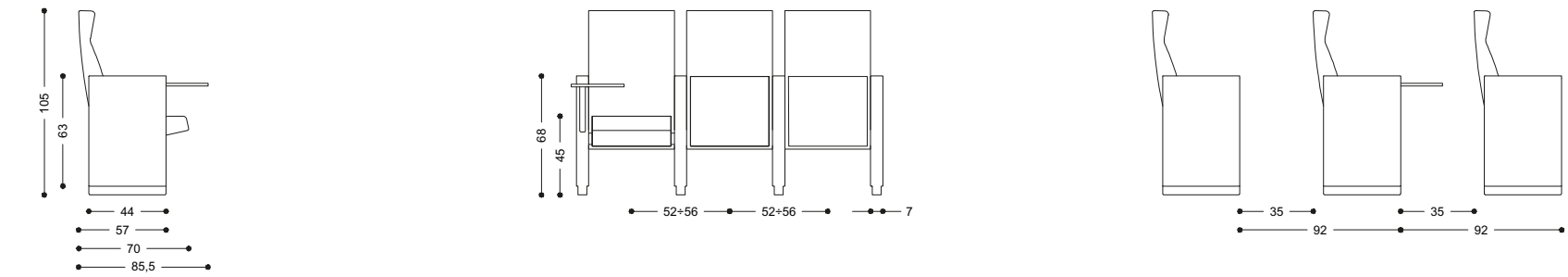

## Dimensioni - Dimensions

C100 su barra schienale basso - C100 on beam with low backrest

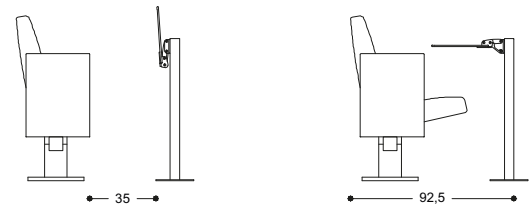
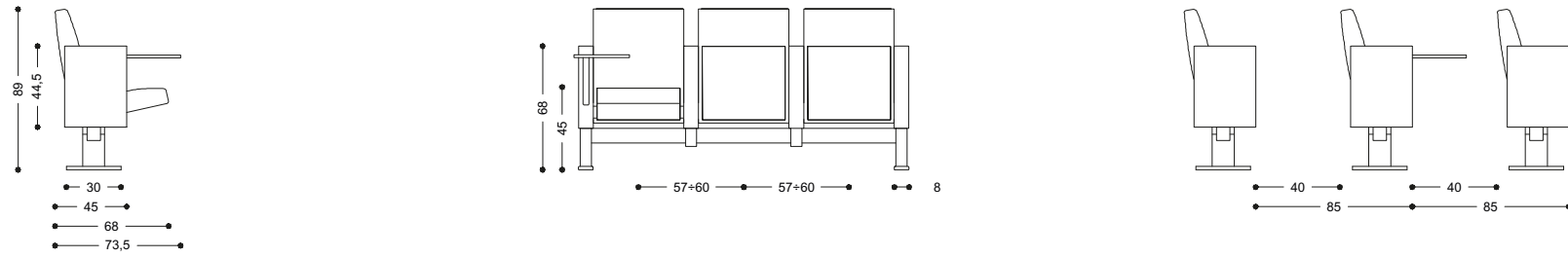
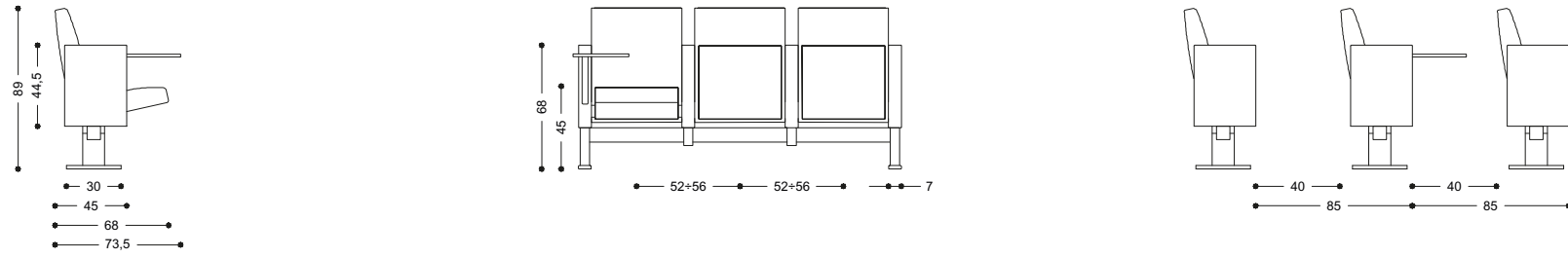

C100 su barra schienale basso - C100 on beam with low backrest

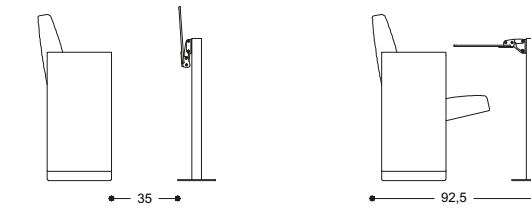
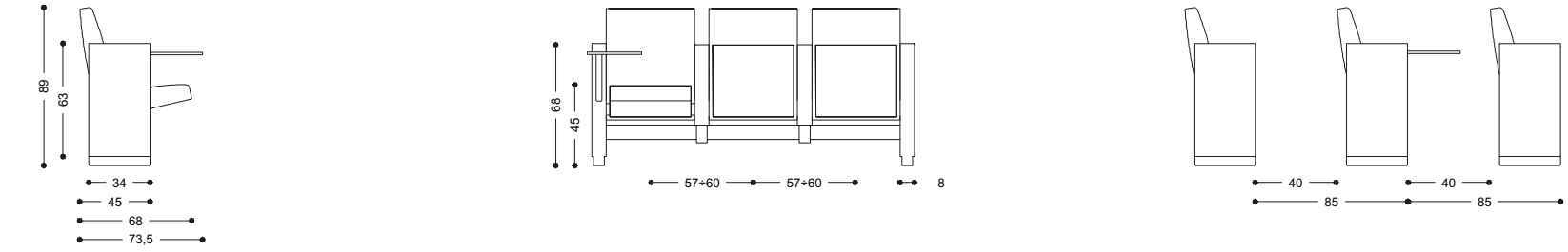
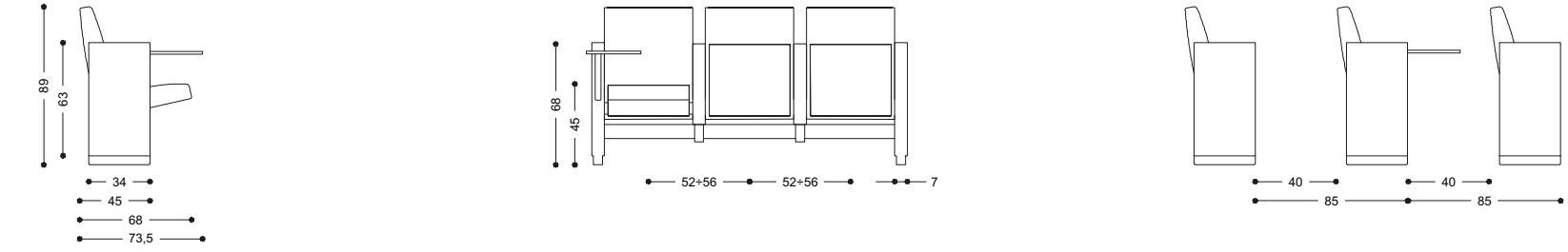



## Dimensioni - Dimensions

C100 su barra schienale alto - C100 on beam with high backrest

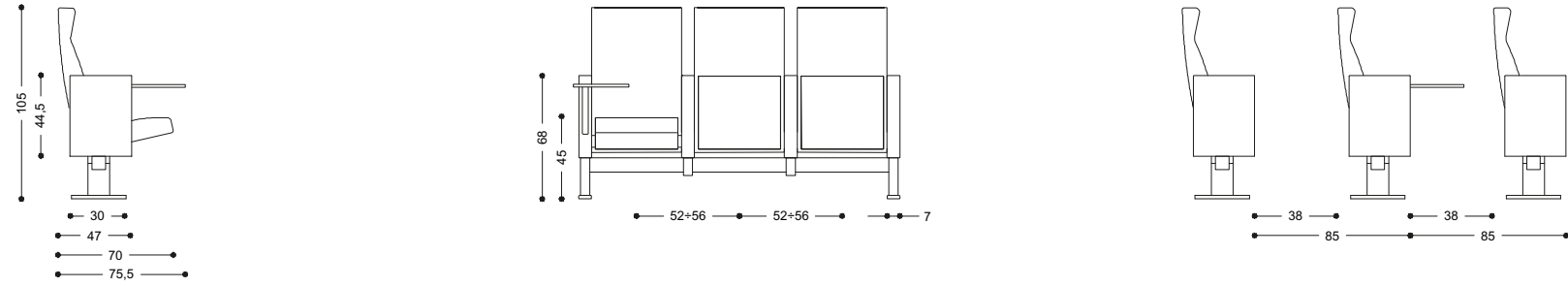

C100 su barra schienale alto - C100 on beam with high backrest

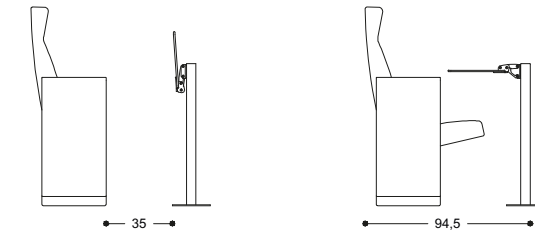
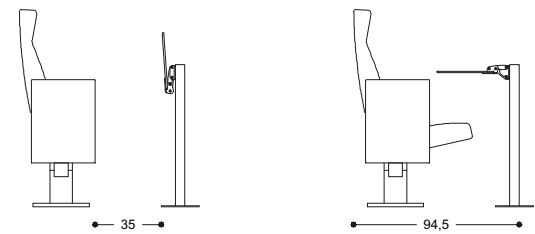
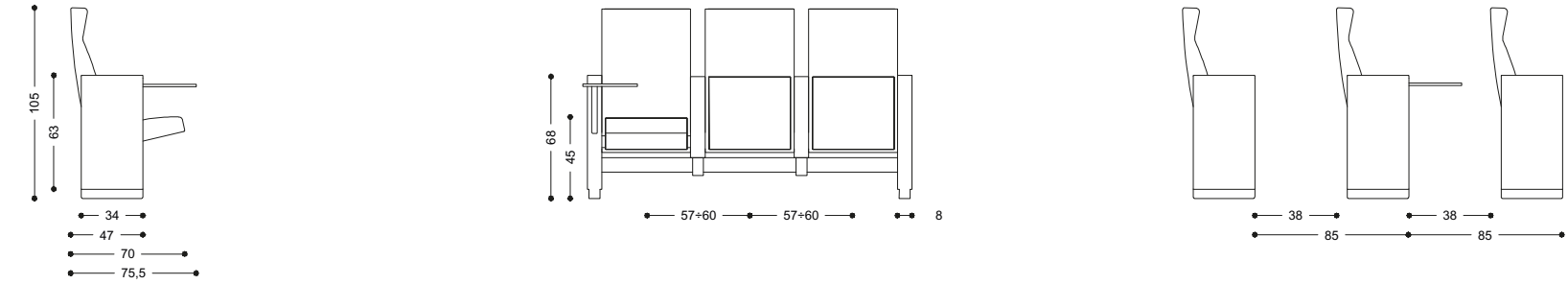
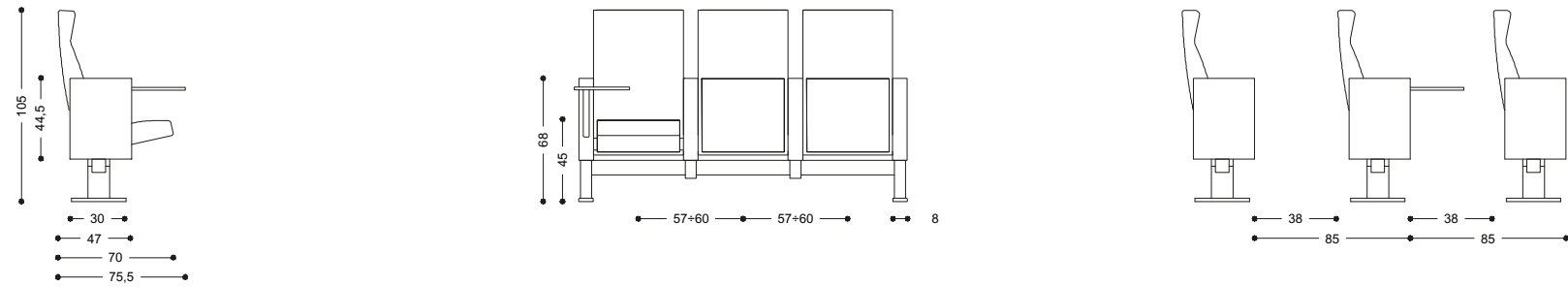
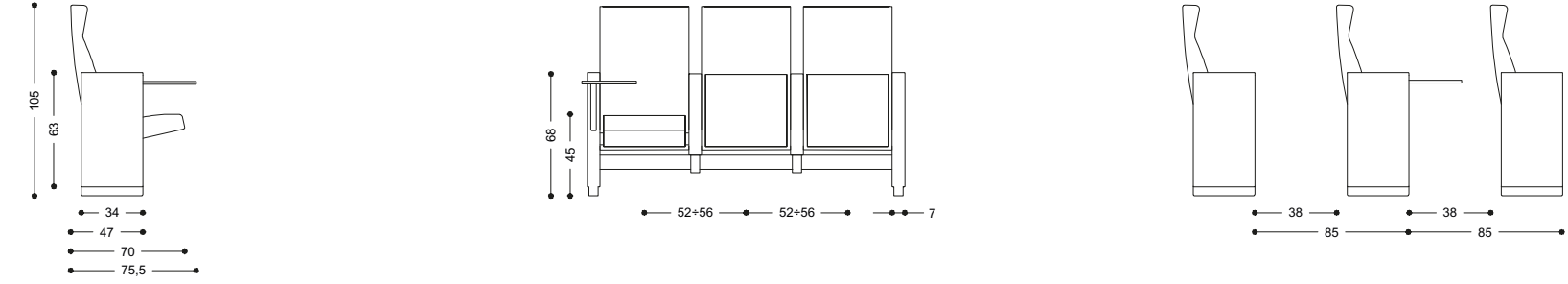

## Accessori - Accessories



Elemento di identificazione fila e numerazione posto  
Row identification element and seat numbering



Predisposizione per l'elettrificazione (presa elettrica su richiesta)  
Provision for electric power supply (socket on demand)



Pannello sotto-sedile in legno verniciato  
Painted wood under seat panel



Tavoletta di scrittura ribaltabile a scomparsa  
Tip-up foldaway writing tablet



Piede anti-ribaltamento per versione su barra  
Anti-tilt foot with registers for version on beam



Sistema che permette l'amovibilità delle poltrone, su ruote, in caso di non utilizzo  
(per poltrone con piedi da fissare a pavimento in file diritte)  
Accessory system allowing the armchairs to be moved, on castors, when not in use (for armchairs with floor fixing feet, in straight rows)



Retro-schienale alto in legno verniciato  
Painted wood high backrest panel



Carter retro-schienale basso in legno verniciato  
Painted wood low backrest panel



Tavolino retro-schienale ribaltabile con movimento anti-panico  
Backrest tip-up table with anti-panic movement



Tavolino di scrittura ribaltabile su base singola mod. T200  
Tip-up writing table on single base mod. T200